

SF25MOBIE36-Boost-ABS-EQ-LORC-PCS-DS-15LH-110-27.5-AL1.8CTS-C74-O51-150,140,130,120

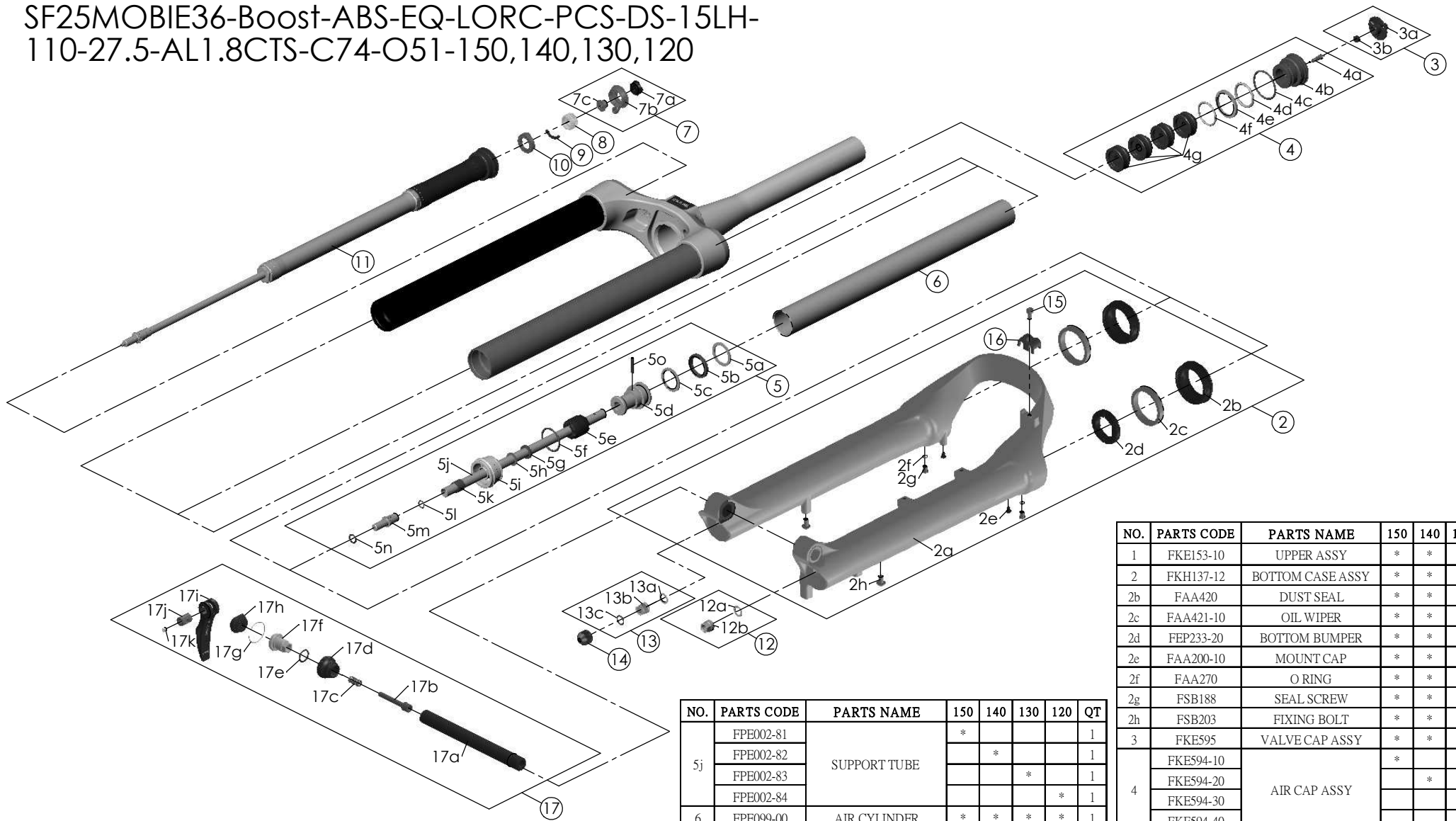

NO.	PARTS CODE	PARTS NAME	150	140	130	120	QT
15	FSB153	GUIDE FIXING BOLT	*	*	*	*	1
16	FEG519	CABLE GUIDE	*	*	*	*	1
17	FKA116-02	15LH-110 AXLE SET	*	*	*	*	1

NO.	PARTS CODE	PARTS NAME	150	140	130	120	QT
5j	FPE002-81	SUPPORT TUBE	*				1
	FPE002-82			*		1	
	FPE002-83				*	1	
	FPE002-84					*	1
6	FPE099-00	AIR CYLINDER	*	*	*	*	1
7	FKE421	LO-RC KNOB ASSY	*	*	*	*	1
8	FEE256-30	ADJUST CORE	*	*	*	*	1
9	FEE258	ADJUST CLICK	*	*	*	*	1
10	FEE257	CLICK HOLDER	*	*	*	*	1
11	FUN131-55	LORC-PCS UNIT	*	*	*	*	1
12	FKA063-03	FIXING NUT SET	*	*	*	*	1
13	FKE436	FIXING NUT SET	*	*	*	*	1
14	FEG201	REBOUND KNOB	*	*	*	*	1

NO.	PARTS CODE	PARTS NAME	150	140	130	120	QT
1	FKE153-10	UPPER ASSY	*	*	*	*	1
2	FKH137-12	BOTTOM CASE ASSY	*	*	*	*	1
2b	FAA420	DUST SEAL	*	*	*	*	2
2c	FAA421-10	OIL WIPER	*	*	*	*	2
2d	FEP233-20	BOTTOM BUMPER	*	*	*	*	2
2e	FAA200-10	MOUNT CAP	*	*	*	*	2
2f	FAA270	O RING	*	*	*	*	2
2g	FSB188	SEAL SCREW	*	*	*	*	2
2h	FSB203	FIXING BOLT	*	*	*	*	2
3	FKE595	VALVE CAP ASSY	*	*	*	*	1
4	FKE594-10	AIR CAP ASSY	*				1
	FKE594-20			*			1
	FKE594-30				*		1
	FKE594-40					*	1
4g	FEG270-10	VOLUME REDUCER	*				4
				*			5
					*		6
					*	7	
5	FKH154-01	SUPPORT TUBE ASSY	*				1
	FKH154-02			*			1
	FKH154-03				*		1
	FKH154-04					*	1