

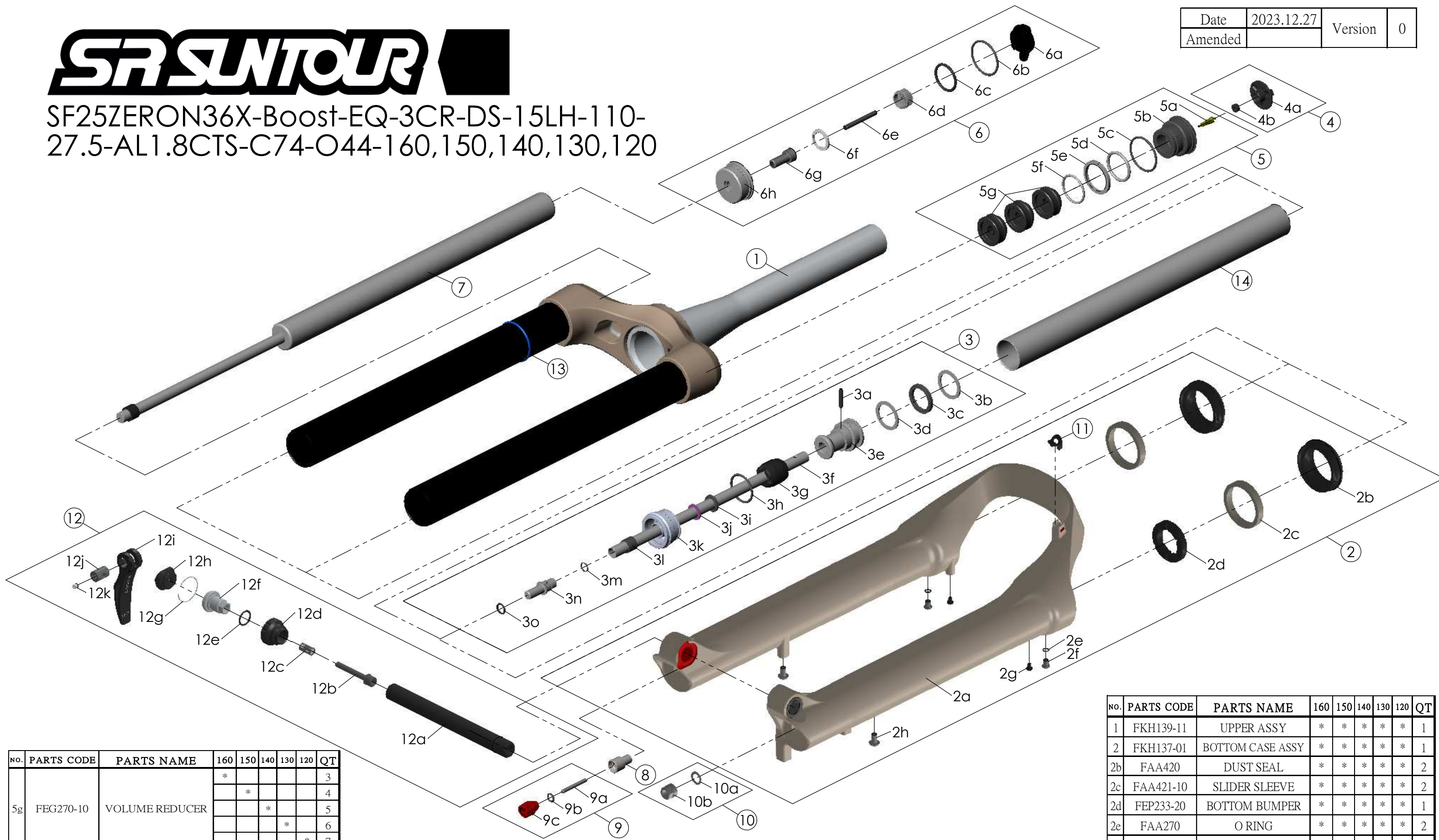

SF25ZERON36X-Boost-EQ-3CR-DS-15LH-110-27.5-AL1.8CTS-C74-O44-160,150,140,130,120

Date	2023.12.27	Version	0
Amended			



NO.	PARTS CODE	PARTS NAME	160	150	140	130	120	QT
			*					3
				*				4
5g	FEG270-10	VOLUME REDUCER			*			5
						*		6
							*	7
6	FKE596-00	3CR TOP CAP ASSY	*	*	*	*	*	1
7	FUN230-65	3CR UNIT	*	*	*	*	*	1
8	FSB058	DAMPER FIXING BOLT	*	*	*	*	*	1
9	FKA004-30	REBOUND KNOB ASSY	*	*	*	*	*	1
10	FKA063-03	FIXING NUT SET	*	*	*	*	*	1
11	FEG034	CABLE CLIP	*	*	*	*	*	1
12	FKA116-02	15LH-110 AXLE SET	*	*	*	*	*	1
13	FAA397-40	O RING	*	*	*	*	*	1
14	FPE099-00	Air Cylinder	*	*	*	*	*	1

NO.	PARTS CODE	PARTS NAME	160	150	140	130	120	QT
	FKE594		*					
	FKE594-10			*				
5	FKE594-20	AIR CAP ASSY			*			1
	FKE594-30					*		
	FKE594-40						*	

NO.	PARTS CODE	PARTS NAME	160	150	140	130	120	QT
	FPE002-80		*					1
	FPE002-81			*				1
3f	FPE002-82	SUPPORT TUBE			*			1
	FPE002-83					*		1
	FPE002-84						*	1
4	FKE595	VALVE CAP ASSY	*	*	*	*	*	1

NO.	PARTS CODE	PARTS NAME	160	150	140	130	120	QT
1	FKH139-11	UPPER ASSY	*	*	*	*	*	1
2	FKH137-01	BOTTOM CASE ASSY	*	*	*	*	*	1
2b	FAA420	DUST SEAL	*	*	*	*	*	2
2c	FAA421-10	SLIDER SLEEVE	*	*	*	*	*	2
2d	FEP233-20	BOTTOM BUMPER	*	*	*	*	*	1
2e	FAA270	O RING	*	*	*	*	*	2
2f	FSB188	SEAL SCREW	*	*	*	*	*	2
2g	FAA200-10	MOUNT CAP	*	*	*	*	*	2
2h	FSB203	FIXING BOLT	*	*	*	*	*	2
	FKH154-00		*					
	FKH154-01			*				
3	FKH154-02	AIR CYLINDER ASSY			*			1
	FKH154-03					*		
	FKH154-04						*	