

Owners Manual 2012.2

HESC - pedelec/ebike components

SR SUNTOUR — **HESC**
Human Electro Synergy Components

English

German

French

Spanish

Dutch

SR SUNTOUR

Table Of Contents

Quick Start Guide	2	“Information Modes”	16
1. How do I turn the system on?	2	How to reset the trip distance..	17
2. Support modes?.....	2	How to reset the trip time (total time)	17
Factors that influence the cruising range	2	How to reset the maximum speed	17
3. What information does the system offer you?	3	Display Indications.....	17
Information mode	3	Speed.....	17
4. How do I remove the display unit?.....	3	Total Distance	18
5. How do I charge the battery?.....	4	Trip Distance	18
6. How to reset trip distance	5	Trip Time (Total Time).....	19
7. Error Code 05 / E05.....	5	Max. Speed	19
Important Safety Information!..	6	Average Speed	20
Before Each Ride!.....	7	Motor status.....	20
Foreword	8	Remaining capacity(fuel gauge)	21
Drive Unit Components	10	Battery - General information ..	22
Display / User Interface	11	Always keep in mind!	24
How to remove the display	12	Battery Charging (upright type battery)	25
How to operate the display/user interface	13	Charging status.....	27
General Information.....	13	Battery indication	27
How to switch ON/OFF	14	Battery Charging (flat type battery)	28
Headlamp control.....	14	Charging status.....	30
Push-up support switch	15	Battery indication	30
How to change the “Assist Mode”	15	Error Codes.....	32
Operating Range.....	15	Maintenance and cleaning	32
Range Influencing Factors	16	Cleaning	32
How to change the		How to disassemble the front wheel.....	33
		How to assemble front wheel..	35
		Limited Warranty	37

Quick Start Guide

Please note that the chapter "Quick Guide" is here to provide you with an initial overview. It does not purport to be complete. For more information, please read the individual chapters of the enclosed user manual (handbook on DVD).

1. How do I turn the system on?



Press the "modus" (M) key for about 2 seconds. The system turns on and shows you all of the important information about the current status.

2. Support modes?

Support mode			
NO. AS	ECO	STD	HI
Cruising range	∅ 66 km	∅ 48 km	∅ 40 km

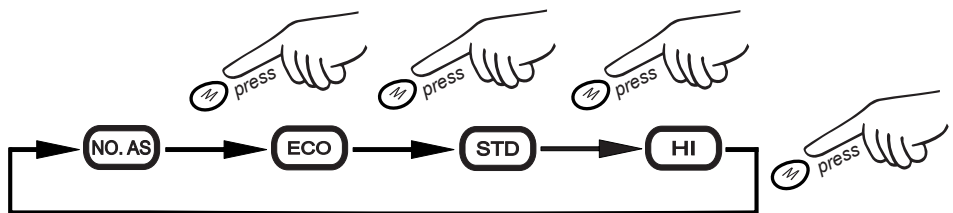

Factors that influence the cruising range

The points stated below can influence the cruising range.

- ▶ Driver characteristics & driver concentration
- ▶ State of maintenance
- ▶ Topography

- ▶ Average speed vs. variation of speed
- ▶ Traffic conditions
- ▶ Type and condition of tires & tire pressure
- ▶ Driver weight
- ▶ Direction of wind & wind speed

-
- ▶ Battery temperature while charging (the lower = the better)
 - ▶ Battery operating temperature while not in use (the higher = the better)
 - ▶ Ambient temperature while driving (the higher = the better)
 - ▶ Battery age (the newer = the better) & battery charge cycle
 - ▶ Battery state of charge
 - ▶ Battery storage (cold and dry storage is recommended)

For more information about cruising range, please read the chapter "cruising range".

3. What information does the system offer you?

Information mode

Information about total kilometers, trip distance, travel time, maximum speed, and average speed is displayed in succession when you push the info "I" button.

4. How do I remove the display unit?



Always close the cover panel after removing the display.

Always turn off system to avoid data loss

For more detailed instructions, please read the chapter "how do I remove the display"

5. How do I charge the battery?

Both battery types shown below can be charged in the installed position and don't need to be disassembled. For more information about "charging the battery" please read the chapter on "charging the battery"

In order to avoid damage, shut off the system before charging.

Upright standing battery type / rear seat tube



- = battery is not getting charged, please check all connections.
- = battery is getting charged
- = battery is fully charged

1. Open the cover of the charging socket.
2. Connect the battery with the battery charger.
3. Connect the battery to the power supply. Next, turn on the battery charger.

The status indicator should light up "red", if not, check the connection.

Flat battery type / carrier

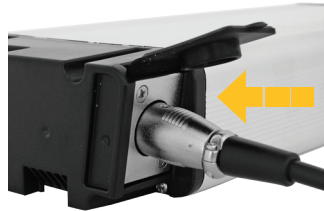

- = Battery is charging.
- = Battery is fully charged.
- = Battery isn't charging, please check all connections.
- = Error (re-connect).
- = Error with battery charger (re-connect).
- = Above charging temperature.

1. Open the cover of the charging socket.
2. Connect the battery with the battery charger.
3. Connect the battery to the power supply.

Next, turn on the battery charger.

The status indicator should light up "red", if not, check the connection.



Battery keys



Your ebike system battery is secured with a lock to avoid theft. Your bike should be equipped with 3 matching keys. Please keep one of these keys in a secure place. In the case that all 3 keys are lost, the entire lock must be replaced.

6. How to reset the trip distance

1. Change the display to "trip distance".
2. First press the "mode" button and then the "info" button. Afterwards release the buttons (buttons are not allowed to remain pressed down).

Please note! When resetting the trip distance, the travel time will also automatically be reset.

In order to reset the maximum speed, change the display to "max speed" and do as stated in the instructions above.

7. Error Code 05 / E05

Error report 05 should be interpreted as a "security measure" and protects the system from overloading.

Your system is equipped with a "torque sensor". After pressing the pedal, the sensor measures the force used and sends the measurement to the controller. In order to offer you a balanced and natural ride, the sensor is very finely adjusted. There are several points to keep in mind so that problem-free operation may be ensured.

Turn on the system before placing your foot on the pedal. If you depress the pedal before turning on the system, the controller may interpret this as a system overload and report this as "error 05".

Solution:

Turn off the system and release the pedal. Afterwards turn the system back on (remove your foot from the pedal). If "error 05" still appears, contact your retailer.

During driving operation:

The front brake lever is equipped with a "disruption sensor". When you pull the brake lever, a signal is sent to the controller. The controller subsequently disrupts the current supply to the motor and tells the torque sensor that no measurements are necessary.

In order to avoid an "error 05", you should always make sure to pull the front brake lever, i.e. while waiting at a red light. This way the system always knows that no assistance is necessary at that moment.

Important Safety Information!



WARNING !

Failure to comply with the given warnings and instructions may cause damage to the product, injuries or even death to the rider and user.

- ▶ Be sure to read this manual carefully before using your electric bicycle. Inappropriate usage of your electric bicycle may cause damage to the product, serious injuries or even death to the rider.
- ▶ Do not use damaged components – consult your authorised SR SUNTOUR dealer immediately.
- ▶ The battery of the electric bicycle contains chemicals which can be dangerous when used improperly, warnings included in this manual must be followed in order to reduce the possibility of dangerous situations resulting in injuries or possible death. Never try to open any SR SUNTOUR device of the electric bicycle, especially not the battery. Opening any SR SUNTOUR battery implies the risk of getting seriously injured.
- ▶ Do not let the battery come into contact with water or any other liquid other than rain or snowfall. The guarantee will be void if the battery gets in contact with water. Whenever the battery gets in contact with liquid immediately disconnect it to prevent dangerous situations.
- ▶ Do not store the battery above room temperature. The battery life expectancy will be significantly reduced if the battery is stored under higher temperatures.
- ▶ Do not place the battery immediately close to a flame or any other heat source. Extreme heat can cause the battery to explode. Keep the area where the battery is charged well ventilated. Keep it free from litter and anything combustible to avoid fire from sparks or overheating.
- ▶ The battery must only be charged with the supplied charger. Using a different charger can result in malfunction and reduced lifecycle of the battery.
- ▶ Charge the Li-ion battery indoors at a temperature between 0°C to 40°C (32°F -104 °F). The Li-ion battery charger cannot charge a battery with a temperature above 60° C or less than -3 °C.
- ▶ If you notice a strange smell or smoke, un-plug the charger immediately from the power socket and disconnect the battery from the charger! Take your battery and charger to your authorized dealer for service or replacement.
- ▶ Disconnect the charger when the battery is fully charged.
- ▶ Use only genuine SR SUNTOUR parts. The use of non-designated aftermarket accessories, replacement and spare parts voids the warranty of the electric bike drive unit and might cause failure to the system.

- ▶ Do not disassemble or modify any of the parts of the drive unit. The warranty will be void in case of any modification.
- ▶ SR Suntour electric bike units are designed for the usage on single seated bicycles for regular and common use on regular city- and trekking bikes. The intended use of the drive unit is accordingly.
- ▶ This instruction sheet contains important information about the correct installation, service and maintenance of your drive unit. Nevertheless please be informed that special knowledge and tools are essential to install, service and maintain SR SUNTOUR drive units for electric bicycles. Common mechanical knowledge may not be sufficient to repair, service or maintain the devices. Therefore we strongly recommend getting your system serviced and/or maintained by a trained and qualified bicycle mechanic. Improper installation, service or maintenance can result in failure of the product, accident, injury or even death.
- ▶ Always be equipped with proper safety gear. This includes a properly fitted and fastened helmet. Make sure your equipment is in flawless condition.
- ▶ Make sure to learn about the electric power assistance, the changed bicycle behaviour and handling of your bike. Learn how to ride and train your skills. Know your limits and never ride beyond those.
- ▶ The torque sensor of your HESC system even detects slight pressure on the pedal. If the torque sensor detects and pressure on the pedal, it will give the motor the instruction to start running. Therefore you should always slightly pull your front brake lever towards the handlebar while standing/waiting. e.g. in front of a traffic light with your foot placed on the pedal. Your brake lever is equipped with a cut of sensor which will avoid the motor to start running unexpectedly.
- ▶ Never lock your front wheel while the system is active as the motor might get damaged. Besides this it could result into a short circuit which might set the system on fire.
- ▶ Always make sure to fold center stand while moving the bike backwards.

Before Each Ride!



Do not ride your bike, if one of the following test criteria can't be passed! Riding your bike without eliminating any defect or carrying out the necessary adjustments can result into an accident, fatal injury or even death.

- ▶ Do you notice any cracks, dents, bent or tarnished parts at your suspension fork or any other part of your bicycle? If so, please consult a trained and qualified bicycle mechanic to check your fork or bike.
- ▶ Can you notice any oil leaking out your fork? Also check out hidden areas like the bottom side of your fork crown. If so, please consult a trained and qualified bicycle mechanic to check your fork or bike.

- ▶ Compress your fork with your body weight. If it feels too soft, relating to the proper pressure to achieve an accurate SAG, inflate it until you have reached the required value. Please also refer to chapter "SETTING SAG"
- ▶ Make sure your brakes are properly installed/adjusted and work appropriate. This also applies to every other part of your bike like handlebars, pedals, crank arms, seat post, saddle etc. Also refer to the owner's manuals provided by all other component manufacturers.
- ▶ Make sure your wheels are centered perfectly in order to avoid any contact with your suspension fork or brake system.
- ▶ If you are using a quick release system to fasten your wheel set, make sure that all levers and nuts are adjusted properly. In case you are using a through axle system, make sure that all fixing bolts are tightened with the appropriate torque values.
- ▶ Check the cable length and routing of your components. Make sure they do not interfere your steering actions.
- ▶ If you are using reflectors for on-road cycling, make sure they are clean and properly installed.
- ▶ Bounce your bike slightly on the ground while looking and listening for anything which might be loose.

Foreword

Dear customer,

congratulations on your new electric bicycle purchase. The bike is equipped with the SR SUNTOUR SRS-pedelec drive unit with a rechargeable Lithium-Ion battery, a display and user interface, a torque sensor, a controller and a brushless front hub motor..

To make your ride smooth, safe and fun please take some time to read this manual carefully. It contains information on the proper care of the drive unit of your electric bicycle and advice on how to achieve the bikes' and batteries' full lifespan.

In case of any enquiries not covered by this manual please contact your local dealer.

Enjoy the ride!

What is a Pedelec?

It is legally considered a conventional bicycle, where the rider is enjoying some electrical power assistance based on the human power brought up by the rider. Just ride like on a conventional bike, the system will add some extra power. It feels like having tailwind or a continuous descending ride.

In European Countries the assistance is legally limited to 250W nominal power and a max. speed of 25km/h. Riding faster than that is possible, but there will be no assistance when

riding faster than 25km/h.

A Pedelec is sometimes called EPAC, Light-Electric-Vehicle (LEV), Hybrid Bicycle or eBike or electric bicycle with Pedal-Assisted-System (PAS).

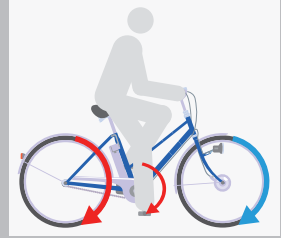

The below stated graphic gives you a better understanding how all HESC components interact with each other.

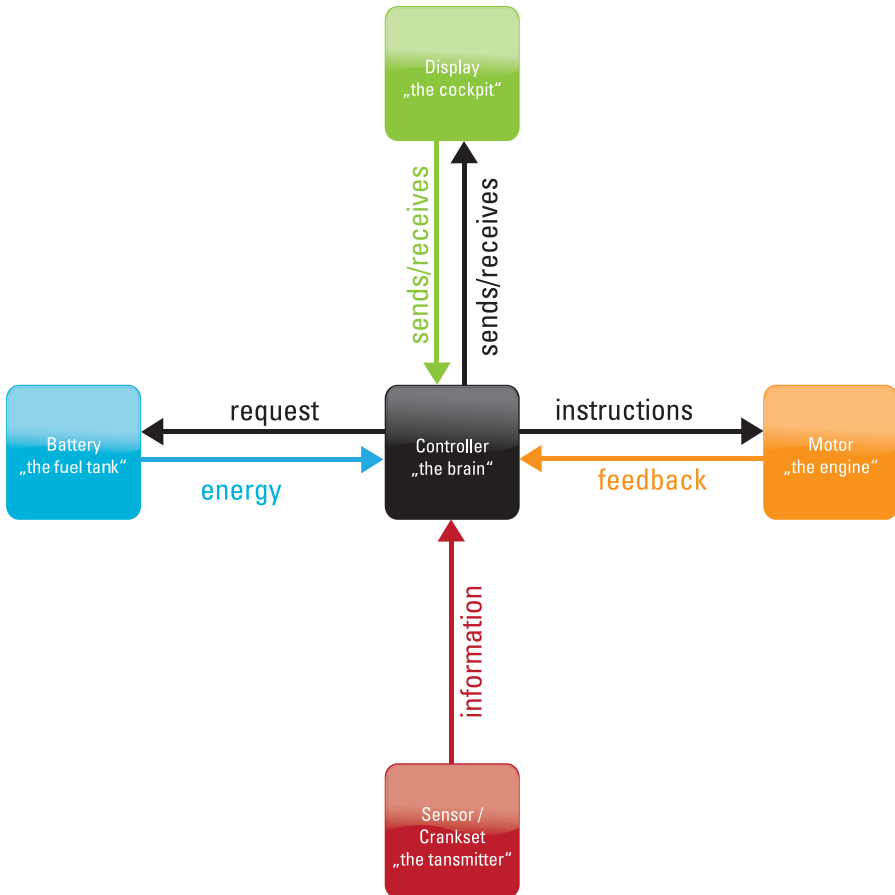

Drive Unit Components

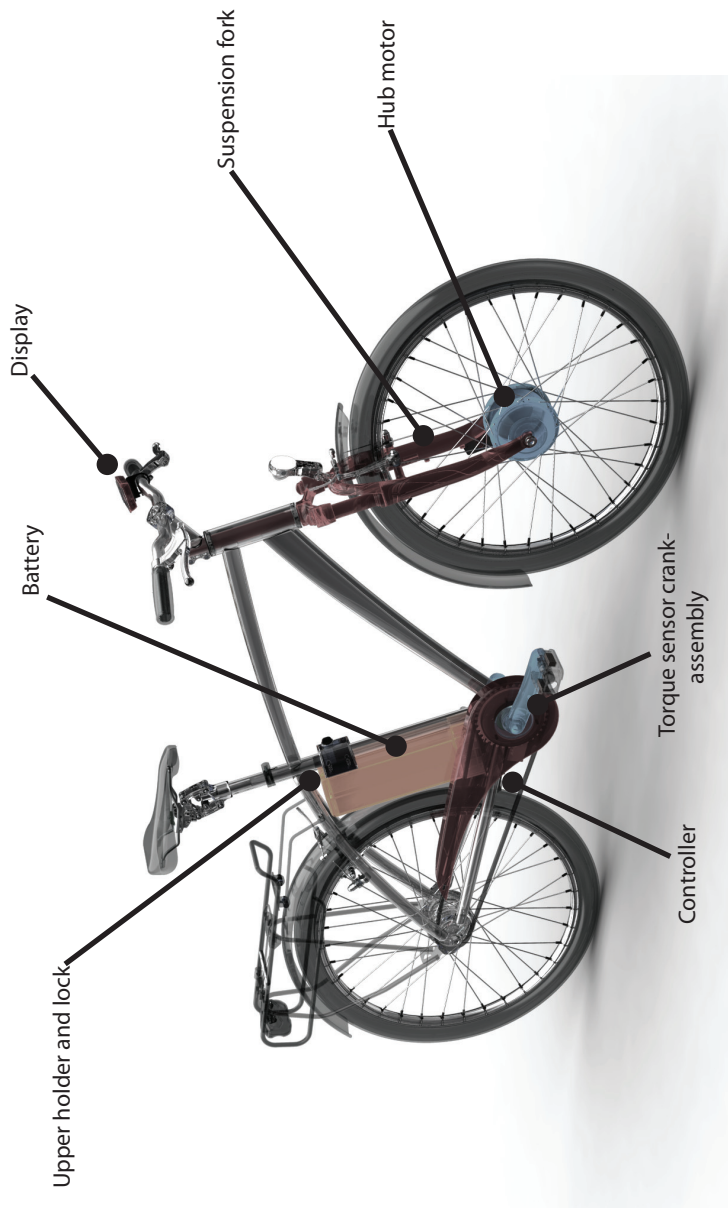

* Shown on a virtual bike which may look different to the bike which this owners manual came along with

*

Display / User Interface

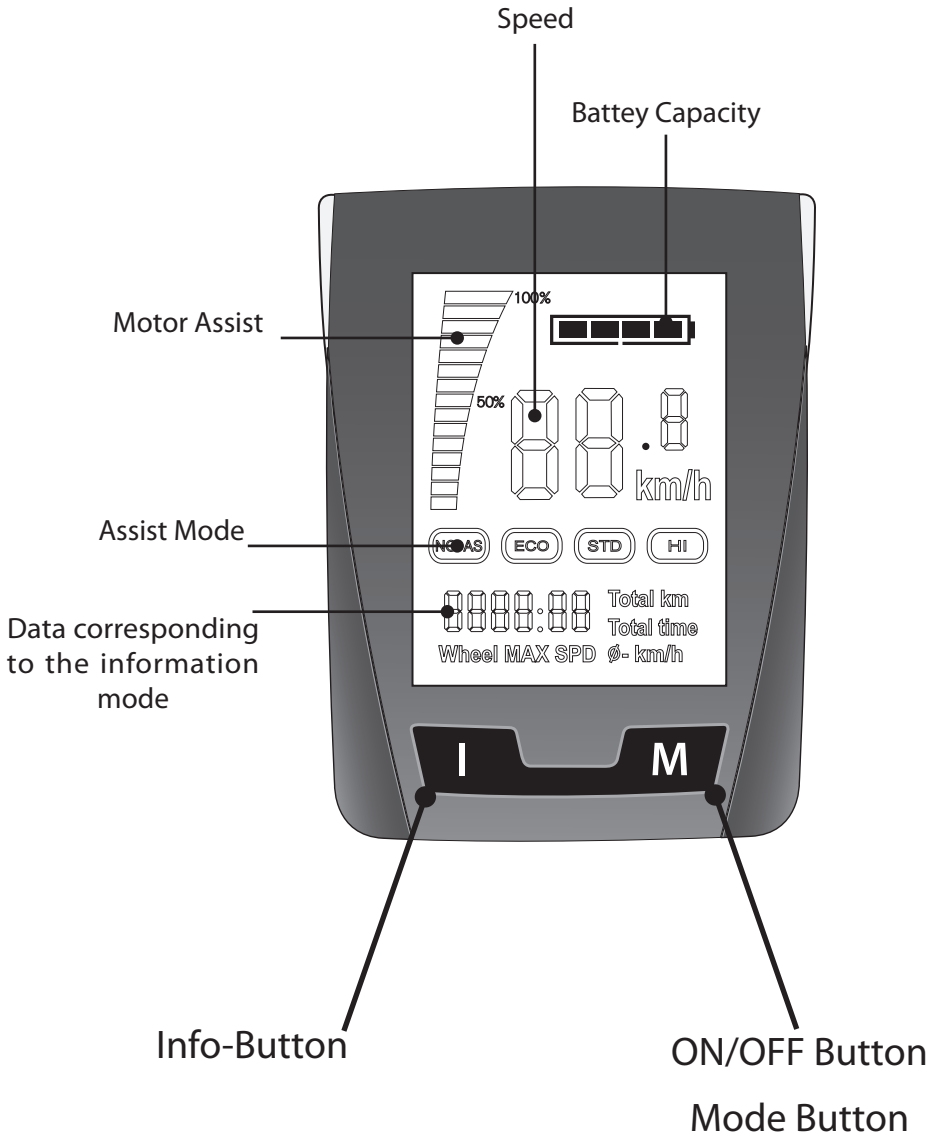

How to remove the display

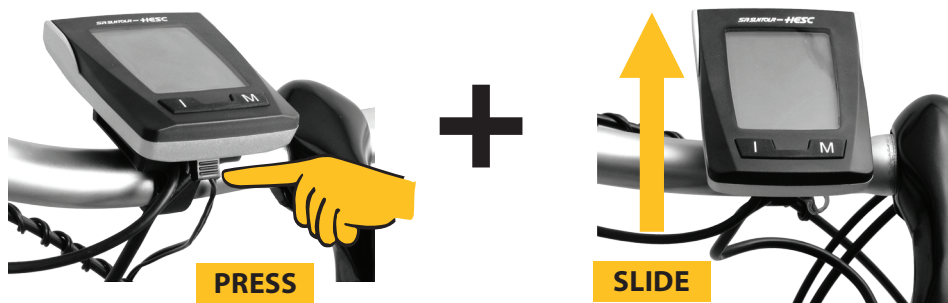

To remove the display off the docking station, carry out the steps like indicated above.

To install the display onto the docking station, slide the display onto the docking station.

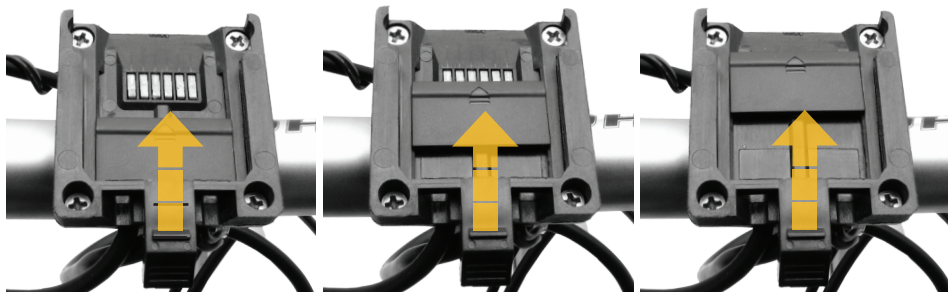

To protect the pins of your docking station against moisture and dirt it is equipped with a cover, which can be slid over the pins. Always cover the pins after you take off the display!

! Always close the cover after removing the display !

Do never expose the pins to any kind of metal like tools, coins or hairpins.

This could result into a short circuit and might cause permanent damage. As a result of this massive heat might build up, this could result into a burning of the display unit.

More over you might expose yourself to an electric shock.

! Make sure to turn off the display before removing it !

Removing the display before turning off may result into a failure of the system.

The display will save all data, like trip distance and average speed, on a flash memory. Removing the display before it has been turned off may result in a loss of stored data.

Never expose the display to any kind of static electricity or strong radio waves as it might erase all data on your display.

How to operate the display/user interface

General Information

The user interface / display is located on the handlebar. When the system is switched on by using the on/off-switch, you can choose among the options below.

- Battery capacity
- Motor status
- Speed
- Assist mode
- Total distance
- Trip distance
- Trip time
- Max speed
- Average speed

The system will switch off automatically after 10 minutes of inactivity.

During the first setup of the bike the wheel size have to be set on this user interface(please refer to the chapter "how to set wheel size").

The display is connected to the controller(brain), the cut off sensor and the push-up support switch.

The power cut off sensor will automatically cut of the power supplied to the motor when pulling the brake lever. The cut off sensor is connected to the front brake. Always use both brakes when braking.

How to switch ON/OFF

To turn ON/OFF the display/user interface press the "MODE" button for at least 3 seconds.

The display will automatically switch off after **10 minutes** if non of the below stated operations are carried out:

- Pushing the Mode Button
- Pushing "push up" support switch
- Applying pressure on the pedal

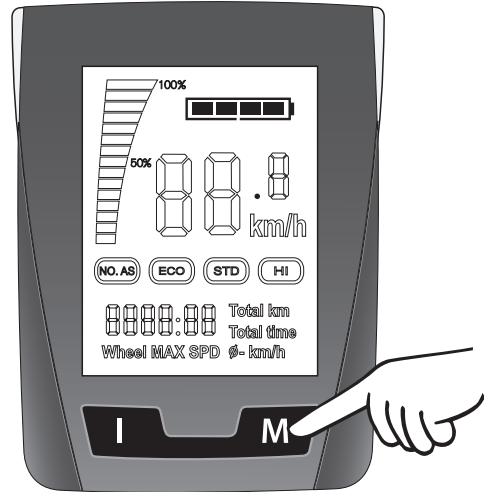

Headlamp control

The controller of the SR Suntour HESC pedelec/ebike system is equipped with a power supply mechanism which will automatically supply power to the the light system of our bike if the system is turn on. As this is not a standard feature, it might not being used on every pedelec or ebike which is equipped with SR Suntour HESC components, please refer to owner's manual of the manufacturer's bike. Before each ride, especially during dawn and darkness, please always check the proper function of your light system.

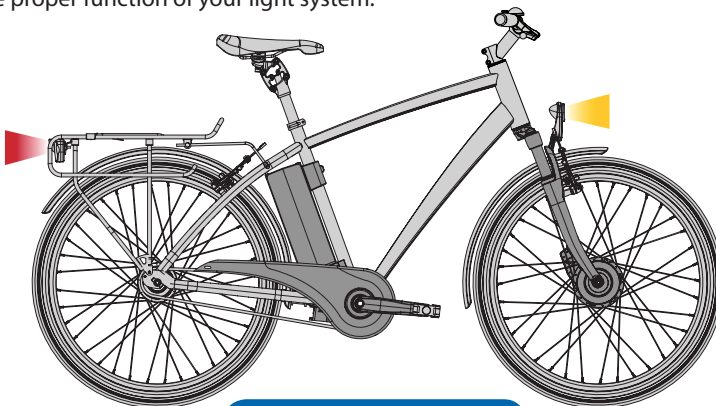

Push-up support switch

Your HESC equipped ebike/Pedelec features a so called „push-up“ support switch which helps you starting up on gradients, while waiting in front of the traffic lights etc. The push up knob supports you until 4-5km/h, beyond this is will be cut off automatically.

Please note! When using the push up support switch, always hold your handelbar with both hands.



How to change the “Assist Mode”

The user can choose the ratio of assistance depending on his personal wish by pressing the Mode-button “M” on the user interface. He can use between 4 different modes: No assistance, ECO Mode, Standard Mode and High Power Mode.

The percentage of assist power varies from 50%(ECO-Mode), 100%(Standard Mode) and 150%(High-Power-Mode).

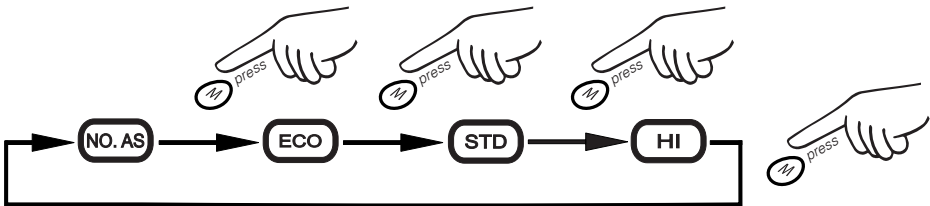

Operating Range

Assist Mode			
NO. AS	ECO	STD	HI
cruising range	∅ 66km	∅ 48km	∅ 40km

Range Influencing Factors

The riding distance might vary as it is influenced by the following factors:

- ▶ Operating Temperature of Battery when not in use (higher = better)
- ▶ Ambient Temperature while riding (higher = better)
- ▶ Battery Age (newer = better) & Battery charge cycles (number of time charged)
- ▶ Battery Condition (state of charge)
- ▶ Battery Storage (Cool, dry place recommended)
- ▶ Driver ability & Driver concentration
- ▶ Condition/repair state
- ▶ Topography
- ▶ Speed – Average / Speed – Variability
- ▶ Traffic conditions
- ▶ Tire style, Tire condition & Tire Pressure
- ▶ Weight of rider
- ▶ Wind direction & Wind speed

How to change the “Information Modes”

The ride information total distance, trip distance, trip time, maximum speed and average speed are shown one after another when pressing the Information-Button “I”.

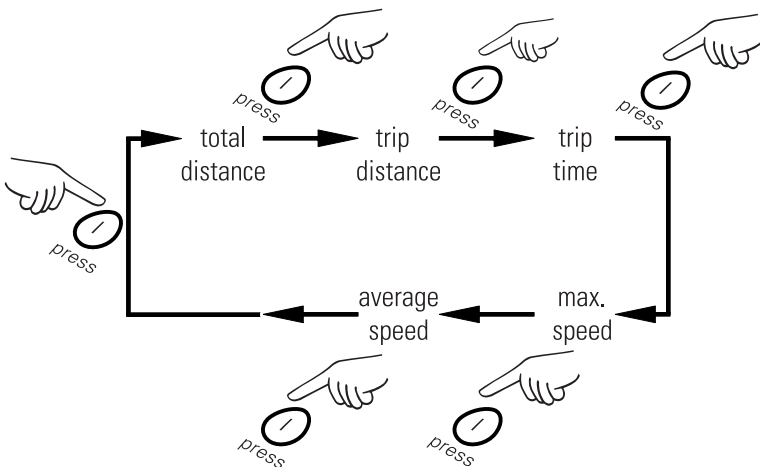

How to reset the trip distance

1. Switch to "trip distance"
2. Press the "Mode" button that followed press the "Info" button. Afterwards release both buttons (the buttons should not remain pressed)

How to reset the trip time (total time)

1. Switch to "trip time"
2. Press the "Mode" button that followed press the "Info" button. Afterwards release both buttons (the buttons should not remain pressed)

How to reset the maximum speed

1. Switch to "maximum speed"
2. Press the "Mode" button that followed press the "Info" button. Afterwards release both buttons (the buttons should not remain pressed)

Display Indications

Speed

The speed is shown in kilometres per hour.

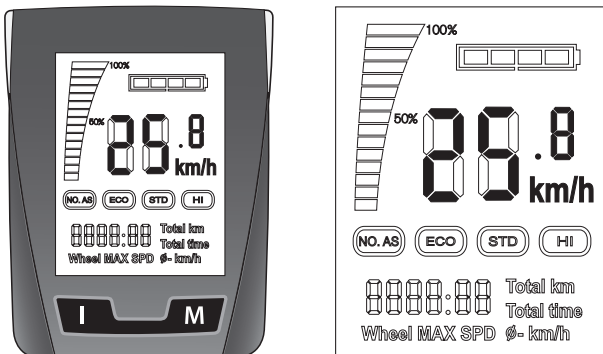

Display speed range: 0.0 - 60.0km/h * (28inch)

Display accuracy: 0.1km/h

*(The system needs approx. 2.5seconds to recognize the speed of the wheel)

Total Distance

The total distance is counted when the system is activated and is displayed in kilometres.

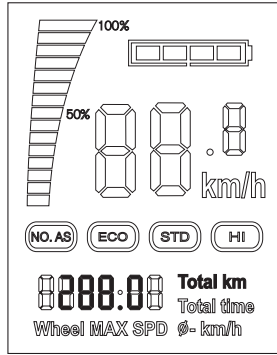
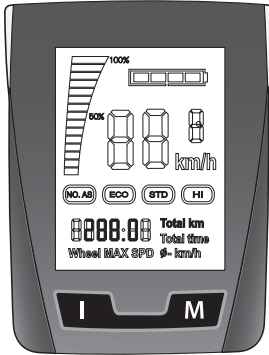

Numerical values will get stored on the non-volatile memory. Value can not be reset manually.
 Display range: 0.0 .. 9999.9km / Display accuracy: 0.1km

Trip Distance

The trip distance is counting when the system is activated and the front wheel is turning.

Display range: 0.0 .. 999.9km / Display accuracy: 0.1km

The trip distance can be reset, please refer to “How to reset the trip distance”

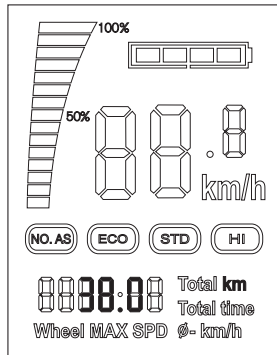
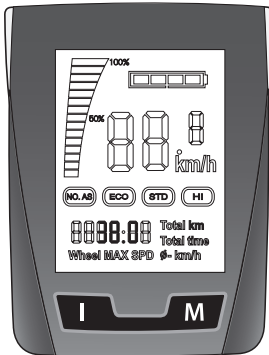

Trip Time (Total Time)

The trip time (total time) is recorded when the system is turned on and the wheel is running.

Display range: 00:00 .. 99:59 hh:mm / 1 unit = 1 minute

The trip distance can be reset, please refer to "How to reset the trip time"

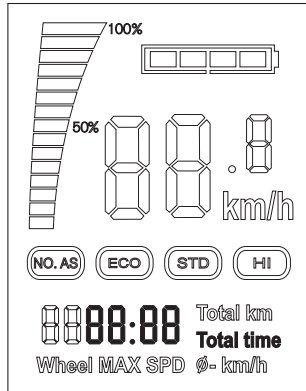
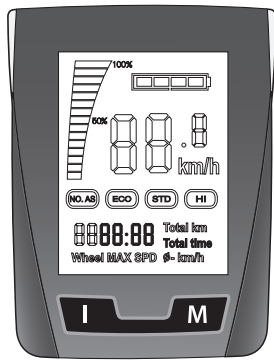

Max. Speed

The "max speed" indicates the maximal ever ridden speed.

Display range: 0.0 .. 60.0km/h / Display accuracy: 0.1km/h

The trip distance can be reset, please refer to "How to reset the maximum speed"

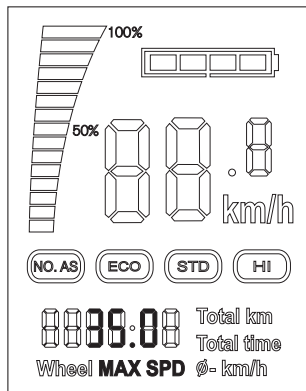
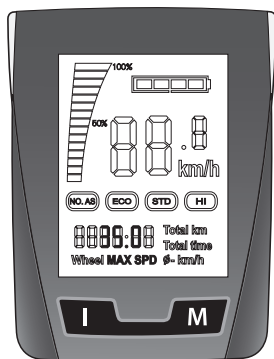

Average Speed

The “average speed” indicates the average ridden speed and is calculated through the following formular: trip distance / trip time

Please note! If the trip time is 0, the “average speed” cannot be displayed.

Display accuracy: 0.1km/h

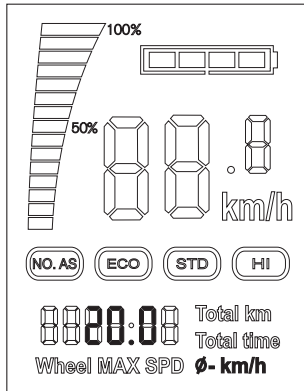
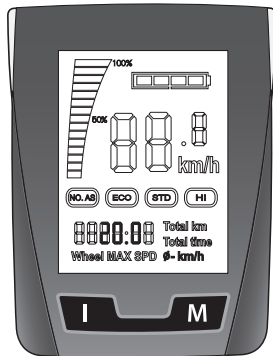

Motor status

The “motor status” indicates the current assist power according to the chosen mode. The motor status will not be indicated beyond a speed of 26km/h.

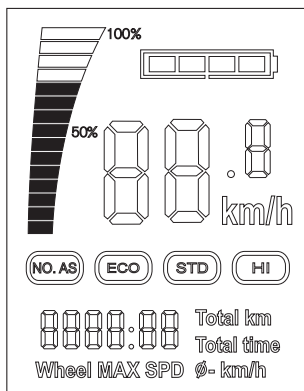

Remaining capacity(fuel gauge)

Please note that the indication of the remaining capacity of the battery is getting update while the motor is inactive

The indication of the remaining capacity of the battery will provide you with precise information regarding the remaining power. However this indication might get influenced by various different outside factors. To avoid any problems please immediately recharge your battery after the indication starts blinking.

When the main switch is turned on, the battery fuel gauge shows up.

The remaining battery capacity is is represented by illustration as follows.

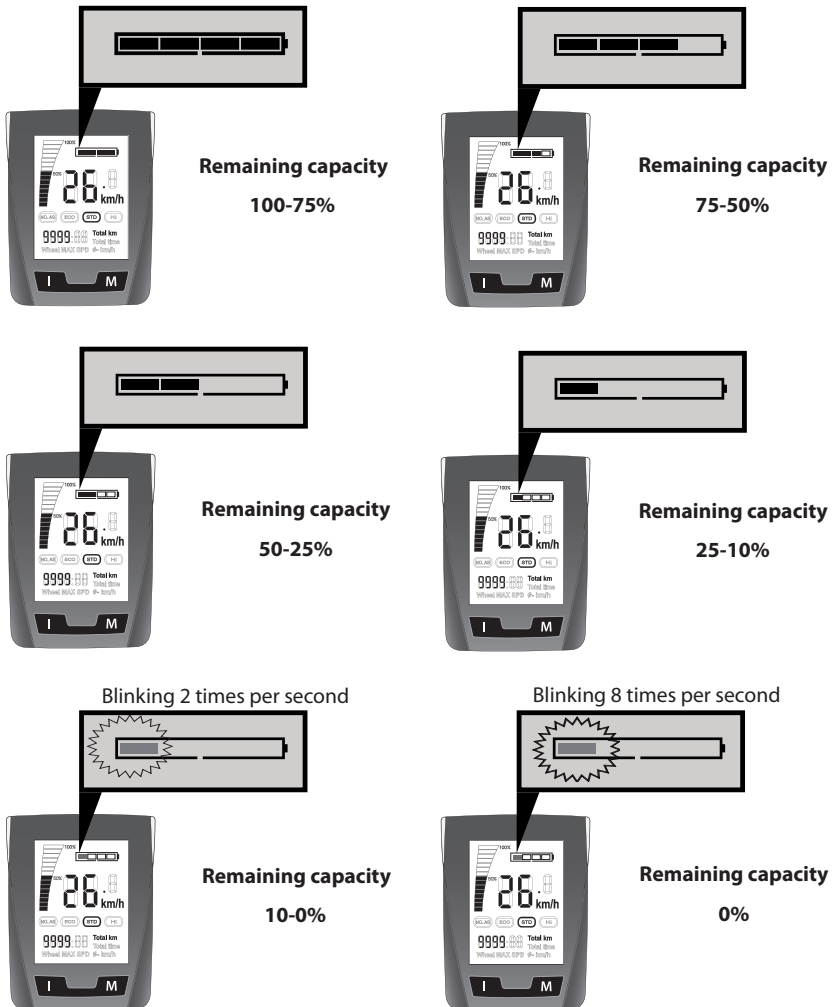

Battery - General information

Our HESC system is equipped with a Li-ION type battery. There are two possible types of batteries your bike is being delivered with. 1. Upright type battery which is located behind the seat tube of your bike, 2. flat type battery, which is located within the rear carrier of your bike.

Li-ION batteries are very user friendly, however to assure a long battery life there are some points to adhered to.



Keys for your battery



To prevent against theft the battery of your ebike system is secured with a lock. Your bike should come with 3 keys each. Please store one key within a save place. If all 3 keys will be lost, the whole lock zyinder must be replaced.

Maximum Range

- Charge the battery at room temperature 0° C to 40° C (32° F to 104° F)
- Discharge the battery as much as possible before recharging it
- Chose a lower gear while uphill riding
- Always make sure your tires are inflated with the prober value

Battery Life

- Min. 300-500 charging cycles
- If battery indication gives information that the battery is fully charged, but the distance you are able to ride does vary from the information given in this manual, your batteries life may have come to an end. In this case please contact your local SR Suntour HESC dealer for further investigations.

Long-term storage

If you are not going to use your battery for a long term period, there are some points to follow. Otherwise your battery might get damaged, which will affect the batteries life.

- Remove the battery from the bike to avoid natural discharging
- Do not store the battery fully charged, approx. 40% is recommended
- Recommended storage temperature -20 ° C to +35° C (-4° F to +95° F)
- As a battery discharges during a certain periode of time, we recommend to recharge the battery every 3 month up to 40% of full capacity.
- Only store battery in a dark room

upright type battery

(located behind seat tube)



flat type battery

(integrated into rear carrier)





Always keep in mind!

- ▶ Recharge the battery before each journey - always recharge if it hasn't been used for at least one month.
- ▶ Li-ion batteries cannot be charged at temperatures over 59°C(138°F) or under -2°C(28°F)
- ▶ Do not recharge your battery in direct sunlight or within a very hot environment.
- ▶ Avoid any contact with water or moisture when recharging your battery. If a plug or socket does get wet, dry it thoroughly before proceeding.
- ▶ Be sure to keep pets and small children away from the area where you are recharging.
- ▶ If you notice a strange smell or smoke, switch off the Power Socket instantly! Take your battery and charger to your authorized dealer for service or replacement.
- ▶ Do not recharge the battery continuously for more than 24 hours. This could seriously reduce the life of the battery.
- ▶ Keep the area where the battery is charged well ventilated. Keep it free from litter and anything combustible to avoid fire from sparks or overheating.
- ▶ Use only genuine SRSUNTOUR Batteries and Chargers with your bike, anything else invalidates your warranty and may cause irreparable harm.
- ▶ Do not throw the battery into a fire.
- ▶ Do not charge the battery with other chargers than the one which has been delivered with your ebike/pedelec.
- ▶ Never try to charge other batteries with the delivered charger.
- ▶ Do not disassemble or modify the battery or charger.
- ▶ Do not connect positive and negative terminals by using metallic objects; be especially careful when inserting any key to ensure that it is not accidentally inserted into the charger socket on any battery.
- ▶ Do not submerge the battery or charger. Soaking either in water may cause irreparable damage. Always make sure that all electronic contacts are free of moisture, grease, oil or any other kind of fluid.
- ▶ Do not subject the battery or charger to shocks, e.g. by dropping.
- ▶ Do not touch the charger with your skin for long periods during charging. Burning of the skin may result.
- ▶ Do not cover the charger or place objects on it.
- ▶ Place the charger firmly on a flat surface. Using the charger upside-down or stretching the

cord tight may result in malfunction, fire or electric shock.

- ▶ Be sure to insert the Power Source Plug fully into a wall socket.
- ▶ Do not touch the Power Source Plug with wet hands.
- ▶ Keep the Power Source Plug clean and free of dust, clean regularly.
- ▶ To remove the Power Source Plug from a socket, do not pull the cable, pull the plug.
- ▶ Do not rotate the pedals when charging the battery whilst it is mounted on the bicycle. The cord may twist around the pedal or the crank, and damage the cable and or plug. In extreme conditions it may cause an electric shock or fire.
- ▶ Use only a power source rated at 100-240 volts AC.
- ▶ Do not use damaged components – consult your authorised SR SUNTOUR Dealer immediately.
- ▶ If the supply Cord is damaged, it must be replaced by the Manufacture or its service agent or a similarly qualified person in order to avoid a hazard.

Battery Charging (upright type battery)

To charge your battery, please follow the steps stated below.

Before you start charging your battery we would like to make you aware of some factors which might influence charging process and range of your battery.

- ▶ Temperature of Battery while charging (lower = better)
- ▶ Operating Temperature of Battery when not in use (higher = better)
- ▶ Ambient Temperature while riding (higher = better)
- ▶ Battery Age (newer = better) & Battery charge cycles (number of time charged)
- ▶ Battery Condition (state of charge)
- ▶ Battery Storage (Cool, dry place recommended)
- ▶ Driver ability & Driver concentration (inadvertently braking with the throttle open)
- ▶ Condition/repair state (a well-serviced SR SUNTOUR improves range)
- ▶ Topography
- ▶ Speed – Average / Speed – Variability
- ▶ Traffic conditions (including vehicles, pedestrians and cyclists, traffic lights etc.)
- ▶ Tire condition & Tire Pressure
- ▶ Weight of rider
- ▶ Wind direction & Wind speed

Your bike is delivered together with a charger. Please only use this charger, don't try to combine with other devices.

Please note: The battery needs an initial full charge before the first use of the bike and after

every use, regardless of the remaining capacity of the battery. The battery doesn't need to be empty before charging it.

One full charge takes up to 4.0 - 4.5 hours, depending on the condition of battery.

To charge the battery please follow these steps:

1. Switch off the system by pressing the "MODE"-button.

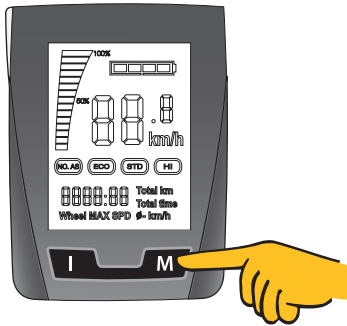

2. Unplug the battery from its docking station.

Please note! You can also charge the battery if it is plugged onto the docking station while mounted onto the bike.



3. Open the cover which protects the socket.



4. Plug the charger cable in.



6. Plug charger into power outlet

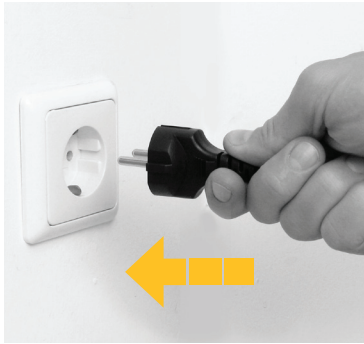

7. The status indication should now shine "red" (ready for use)



8. During the charging process the status indication will turn to "orange"



Charging status

- = battery is not getting charged, please check all connections.
- = battery is getting charged
- = battery is fully charged

Battery indication

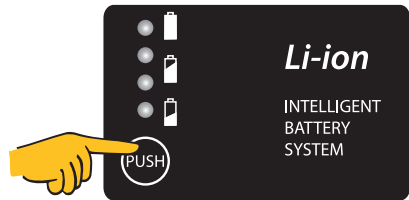

Your upright type battery provides you with 3 different indications:

1. Remaining capacity (press button for 1sec)

Provides you with information about the remaining capacity of your battery.

LED Indicator	Remaining capacity
● ● ● ●	100 - 75%
● ● ● ○	75 - 50%
● ● ○ ○	50 - 25%
● ○ ○ ○	25 - 10%
⊙ ○ ○ ○	10 - 0%
⊙ ⊙ ⊙ ⊙	Over Temperature

○ no light ● light ⊙ blinking

2. Absolute capacity (press button for 3 sec)

Gives information about the total absolute capacity of your battery. It can also be seen as a indicator of battery life.

LED Indicator	Absolute capacity
● ● ● ◎	0 - 80%
● ● ◎ ○	79 - 70%
● ◎ ○ ○	69 - 60%
◎ ○ ○ ○	59 - 0%

○ no light ● light ◎ blinking

3. Charge count (press button for 6 sec)

Provides information about how many times your battery has been charged. 1 charge counts if the battery is getting charged with more than 10%.

LED Indicator	Charge count
● ● ● ●	0 - 99
● ● ● ○	100 - 189
● ● ○ ○	190 - 269
● ○ ○ ○	270 - 349
◎ ○ ○ ○	350 - 0

○ no light ● light ◎ blinking

Battery Charging (flat type battery)

To charge your battery, please follow the steps stated below.

Before you start charging you battery we would like to make you aware of some factors which might influence charging process and range of your battery.

- ▶ Temperature of Battery while charging (lower = better)
- ▶ Operating Temperature of Battery when not in use (higher = better)
- ▶ Ambient Temperature while riding (higher = better)
- ▶ Battery Age (newer = better) & Battery charge cycles (number of time charged)
- ▶ Battery Condition (state of charge) & Battery Recovery Time (how soon after last journey)
- ▶ Battery Storage (Cool, dry place recommended)
- ▶ Driver ability & Driver concentration (inadvertently braking with the throttle open)
- ▶ Condition/repair state (a well-serviced SR SUNTOUR improves range)
- ▶ Topography
- ▶ Speed – Average / Speed – Variability
- ▶ Traffic conditions (including vehicles, pedestrians and cyclists, traffic lights etc.)
- ▶ Tire condition & Tire Pressure
- ▶ Weight of rider
- ▶ Wind direction & Wind speed

Your bike is delivered together with a charger. Please only use this charger, don't try to combine with other devices.

Please note: The battery needs an initial full charge before the first use of the bike and after

every use, regardless of the remaining capacity of the battery. The battery doesn't need to be empty before charging it.

One full charge takes up to 5 hours, depending on the condition of battery.

To charge the battery please follow these steps:

1. Switch off the system by pressing the "MODE"-button.

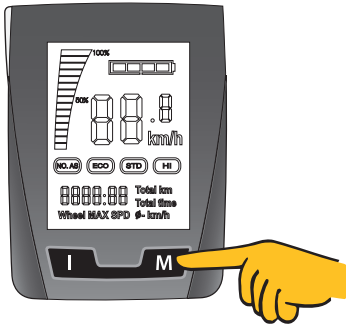

2. Take the battery out of the rear carrier
For more detailed information please refer to your rear carrier manufacturers manual.

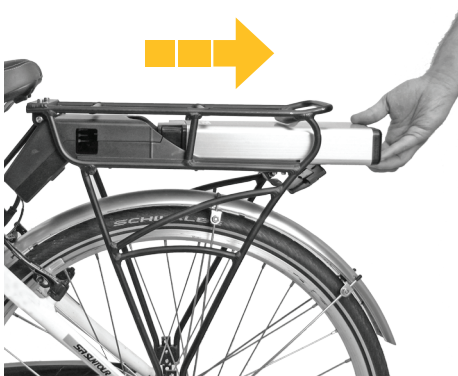

3. Open the cover which protects the socket (it is located at the left end of the battery)

Please note! You can also charge the battery if it is plugged onto the docking station while mounted onto the bike



4. Plug the charger cable in



5. Plug charger into power outlet

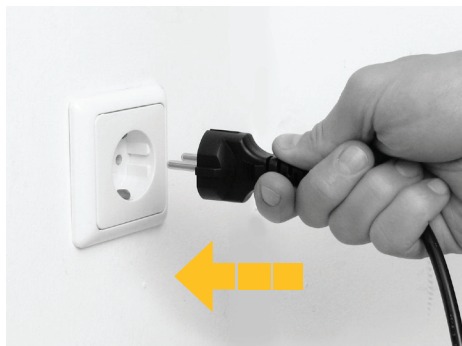

6. Status LED should now shine red

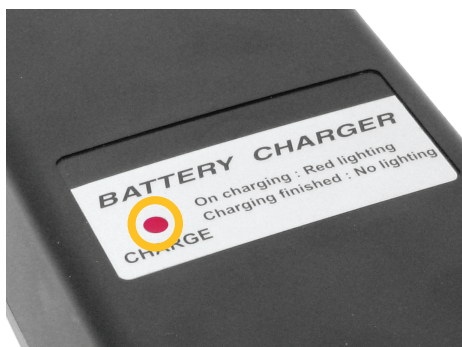

Charging status

- = battery is getting charged
- = battery is fully charged
- = battery is not getting charged, please check all connections.
- = failure battery (unplug and try again)
- = failure charger (unplug and try again)
- = out of operating temperature range

Battery indication

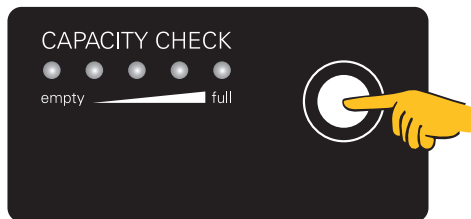

Your flat type battery provides you with 3 different indications:

1. Remaining capacity

(press button for 1 sec)

Provides you with information about the remaining capacity of your battery.

Remaining Capacity	
LED Indicator	Remaining capacity
● ● ● ● ●	100 - 80%
● ● ● ● ○	79 - 60%
● ● ● ○ ○	59 - 40%
● ● ○ ○ ○	39 - 20%
● ○ ○ ○ ○	19 - 10%
⊙ ○ ○ ○ ○	9 - 3%

○ no light ● light ⊙ blinking

2. Absolute capacity

Gives information about the total absolute capacity of your battery. It can also be seen as an indicator of battery life.

1. Push button for 1 sec. (remaining capacity mode shows up)
2. Release button for 1 sec.
3. Press button for at least 10 sec.

Absolute Capacity	
LED Indicator	Absolute capacity
○ ● ● ● ●	- 80%
○ ● ● ● ◎	79 - 60%
○ ● ● ● ○	69 - 60%
○ ● ● ◎ ○	59 - 50%
○ ● ● ○ ○	49 - 40%
○ ● ◎ ○ ○	39 - 30%
○ ● ○ ○ ○	29 - 20%
○ ◎ ○ ○ ○	19 - 0%

○ no light ● light ◎ blinking

3. Charge count

Provides information about how many times your battery has been charged. 1 charge counts if the battery is getting charged with more than 10%.

1. Push button for 1 sec. (remaining capacity mode shows up)

2. Release button for 1 sec.

3. Press button for at least 10 sec (absolute capacity mode shows up)

4. Release button for 1 sec.

5. Press button for at least 10 sec

Charge Count	
LED Indicator	Charge count
◎ ○ ○ ○ ○	0-49
● ○ ○ ○ ○	50 - 99
● ◎ ○ ○ ○	100 - 149
● ● ○ ○ ○	150 - 199
● ● ◎ ○ ○	200 - 249
● ● ● ○ ○	250 - 299
● ● ● ◎ ○	300 - 349
● ● ● ● ○	350 - 399
● ● ● ● ◎	400 - 449
● ● ● ● ●	450 - 499

○ no light ● light ◎ blinking

Error Codes



Your SR Suntour HESC ebike/pedelec system is equipped with an automatic error message report system (EMRS). This system has been developed to provide you with immediate and effective feedback in case your system detected a major problem. This system has to be seen as first aid help tool, please always visit your local dealer if any error messages show up.

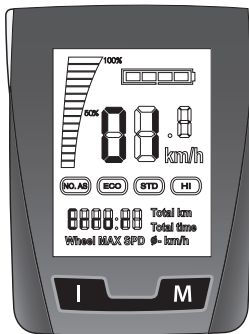

Maintenance and cleaning

Cleaning

If your bike or any component of the electric bike unit is dirty, be sure to remove the battery before cleaning the bike. Clean it with a soft, damp cloth and neutral cleaner or a solution of dishwashing detergent and water. Never use a high-pressure cleaner. Never bring the battery into direct contact with water. If the battery needs to get cleaned use a moistly sponge or similar to clean it. Never use industrial solvents or aggressive chemicals for cleaning.

Before inserting the battery make sure to dry the contacts of the lower battery holder and battery.



WARNING !

When the battery gets in contact with more water than it gets during common rain- or snowfall there is a danger of explosion.

How to disassemble the front wheel

To remove the front wheel off your bike, please follow the steps indicated below.



WARNING!

Remove the battery from the bike before opening any cable connection and before removing the front wheel.

1. Remove the cable guide by using a 4mm Allen key



2. Unplug the cord



3. Unfasten the nuts using a 19mm flat wrench



4. Before removing the front wheel, remove the washer which secures the axle.



How to assemble front wheel

1. Reinstall the washer to secure the axle



2. Tighten the fixing bolt with 25-30Nm by using a flat wrench



3. Re-connect the cord.



4. Reassemble the cable guide by using a 4mm Allen key. Tighten screws with 1 Nm..



Limited Warranty

SR SUNTOUR warrants its pedelec drive unit to be free from defects in material and workmanship under normal use for a period of two years from the date of original purchase. Excluded from this warranty is the Li-Ion Battery. The battery warranty is 1 year. This warranty is made by SR SUNTOUR Inc. only with the original purchaser and is not transferable to any third party. Lodging a claim under this warranty must be made through the dealer where the bicycle equipped with the drive unit was purchased. To prove the original purchase the original retail invoice has to be provided.

LOCAL LAW:

This warranty gives you specific legal rights. According to the state (USA) or province (Canada) or any other country you are living in, you may have other rights than explained within these warranty regulations. These regulations shall be insofar adapted to the local law to be consistent with such law.

LIMITATION OF WARRANTY

This limited warranty does not apply to any defect of the component caused by: improper installation, disassembling and re-assembling, intentional breakage, alterations or modification to the component, any unreasonable use or abuse of the product or any use for which this product was not intended for, accidents, crashes, improper maintenance, repairs improperly performed.

The obligation of this "Limited Warranty" is restricted to repairs and replacements of the components or any parts of it in which there is a defect in materials or workmanship within a period of two years.

SR SUNTOUR makes no express or implied warranties of fitness or merchantability of any kind, except as set forth above. Under no circumstances will SR SUNTOUR be liable for incidental or consequential damages.

Damages which are caused by the use of other manufacturer's replacements parts or damages which are caused by the use of parts that are not compatible or suitable to SR SUNTOUR drive units are not covered by this warranty.

This warranty does not apply to normal wear and tear.

www.srsuntour-cycling.com

SR SUNTOUR HEADQUARTER

SR SUNTOUR INC.

#7 Hsing Yeh Rd.

Fu Hsing Industrial Zone

Chang Hua

Taiwan, R.O.C.

Tel.: +886 4 769115

Fax: +886 4 7694028

email: orders@srsuntour.com.tw

SR SUNTOUR EUROPE

SR SUNTOUR EUROPE GMBH

Am Marschallfeld 6a

83626 Valley

Germany

Tel.: +49 8024 473 99 0

Fax: +49 8024 4730984

email: service@srsuntoureurope.com

SR SUNTOUR NORTH AMERICA

SR SUNTOUR NORTH AMERICA INC.

14511 NE 10th Avenue, Unit E

Vancouver, Washington 98685 USA

Tel: +1 360 737 6450

email: service@srsuntourna.com

SR SUNTOUR